

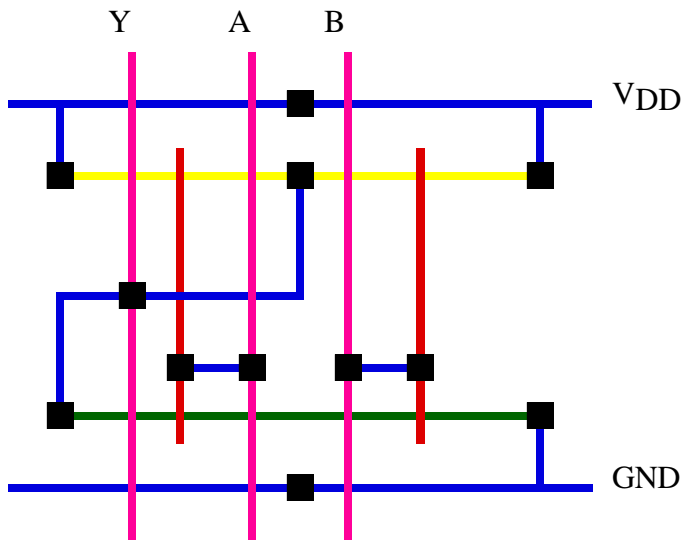











NAND

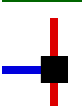

LEGEND

-  metal1
-  metal2
-  poly
-  p+ diff
-  n+ diff
-  m1-to-poly contact
-  p+ diffusion contact
-  n+ diffusion contact
-  m1-to-m2 contact
-  GND p-substrate contact
-  VDD n-well contact